

MADE IN
ITALY





Butler

Torek 5

BASELESS SERIES

**TOREK
5.337**

LIFTS

-  **SOLLEVATORI ELETTROMECCANICI A DUE COLONNE SENZA PEDANA**
-  **ELECTROMECHANICAL TWO POSTS BASELESS LIFTS**
-  **ELEKTROMECHANISCHE 2-SÄULEN-HEBEBÜHNEN MITTELSTEGFREI**
-  **ELEVATEURS ELECTROMECHANIQUES DEUX COLONNES SANS BASE**
-  **ELEVADORES ELECTROMECHANICOS DE DOS COLUMNAS SIN PEANA**

TOREK5.337WK / 3200 kg

TOREK5.337LWK / 3200 kg Large

Bracci corti a tre stadi per il sollevamento asimmetrico agevole anche di veicoli larghi - altezza minima tamponi di soli 95 mm. Bracci predisposti per l'alloggiamento rapido di prolungh.

Three - stage short arms for asymmetric lifting of large vehicles - min. pad height 95 mm. Arms suitable for quick drop-in extensions.

Kurze Arme zweimal ausziehbar um leichter auch breite Fahrzeuge asymmetrisch hochzuheben - Unterschwenkhöhe nur 95 mm. Aufnahmen mit Schnellstecksystem erleichtern den Einsatz von Verlängerungen.

Bras courts à 3 étages, pour faciliter le chargement asymétrique de véhicules larges des tampons de 95 mm. Bras prédisposés pour le montage rapide de rallonges.

Brazos cortos de triple extensión, para el levantamiento de vehículos anchos también altura mínima de los tacos del suelo solamente 95 mm. Brazos predisuestos para el alojamiento rapido de extensiones.



Lubrificazione permanente e automatica delle chiocciole per garantire una lubrificazione efficace durante il movimento di salita e discesa

Automatic and permanent nut lubrication system to guarantee efficient lubrication during lifting and descent

Automatische Dauerschmierung der Muttern für eine wirksame Schmierung beim Hoch- und Runterfahren

Lubrification permanente et automatique des écrous, efficace pendant la montée et la descente

Lubricación permanente y automática de las tuercas para garantizar una lubricación eficaz durante el movimiento de subida y bajada

Chioccia portante in bronzo ad elevata resistenza all'usura (non plastica) a garanzia di sicurezza totale

Main nut made of bronze (no plastic) with high resistance to wear, for greater safety

Verschleissfeste Trage mutter aus Bronze (nicht Kunststoff) für eine totale Sicherheit

Ecrou porteur en bronze à haute résistance à l'usure (pas de plastique) pour garantir une sécurité totale

Tuerca principal en bronce de alta resistencia al desgaste (no es de plástico) para garantizar la seguridad total



Arresto bracci a inserimento automatico e sgancio automatico a terra - geometria conica con effetto autobloccante

Automatic arm locking during lifting and automatic unlocking when the arm reaches the floor - self locking conical design

Automatische Armarretierung, erleichtert durch eine konische Geometrie

Blocage de bras automatique, dégagé au sol - géométrie conique autobloquante

Bloqueo de brazos automatico y desenganche de brazos automáticamente del suelo - geometria conica con efecto auto-bloqueador



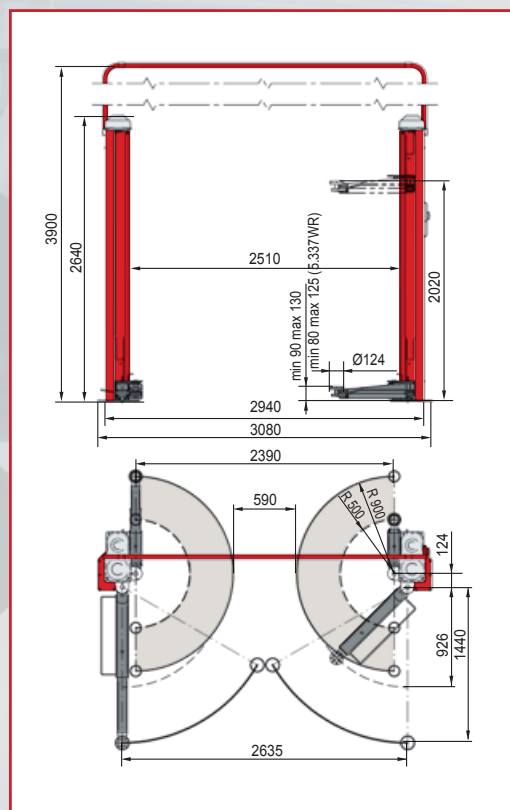

TOREK 5.337WK

OPTIONS



S224A4 (→ K models)
 140 mm extensions (4 x kit)

S224A3 (→ K models)
 80 mm extensions (4 x kit)



S5.337A2
 Transporter frame
 adapter (2 x kit)

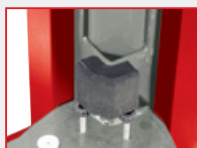

S5.337A9 (2 x kit)
 Set parasportelli
 Set of door protections
 Satz Türansschläge
 Kit protection portes
 Juego de protecciones para puertas